

**Sonterra™**  
LF-WL8-SNP

8" - 20" Widespread Faucet  
Grifo de largo alcance de 8 a 20 pulgadas  
Robinet Élongé de 8 à 20 po

Quick Installation Guide  
Guía de Instalación Rápida  
Guide d'Installation Rapide



Installation Support • Soporte de Instalación • Support d'Installation

Personal Assistance, Product Specs, & "How-to" Questions:

Asistencia personal, especificaciones del producto y preguntas sobre "cómo hacerlo":

Aide personnelle, spécifications du produit et questions « pratico-pratiques » :

**1-800-PFAUCET (732-8238)**

**pfisterfaucets.com/support**

Installation Videos Available  
Videos de instalación a disposición  
Vidéos d'installation disponibles



pfisterfaucets.com/videos

**⚠ WARNING / ADVERTENCIA / AVERTISSEMENT**

To reduce the risk of injury or property damage, read all instructions before installing product. Wear safety goggles. Product must be installed in accordance with all state & local plumbing & building codes. Call a professional if you are uncertain about installing this product.

Para disminuir el riesgo de lesiones o daños a la propiedad, lea todas las instrucciones antes de instalar el producto. Utilice gafas de seguridad. El producto deberá instalarse de acuerdo con la normativa de plomería y construcción estatal y local. Llame a un profesional si no está seguro sobre cómo instalar este producto.

Pour réduire le risque de blessures ou de dommages, lire toutes les instructions avant d'installer l'appareil. Porter des lunettes de sécurité. Il faut installer l'appareil en respectant tous les codes de construction et de plomberie locaux et d'État. Appelez un professionnel si vous n'êtes pas certain de la façon d'installer cet appareil.

**Required Tools**

Herramientas necesarias  
Outils nécessaires

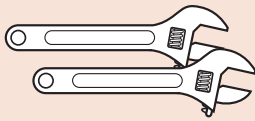

Adjustable Wrenches  
Llaves ajustables  
Clés à mollette



Phillips Screwdriver  
Destornillador de estrella  
Tournevis Phillips



Safety Goggles  
Gafas de seguridad  
Lunettes de sûreté

**Additional Helpful Tools**

Otras herramientas útiles  
Outils supplémentaires utiles

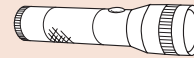

Flashlight  
Linterna  
Lampe De Poche



Cloth  
Paño  
Chiffon

**Parts in the Box • Piezas en la caja • Pièces dans la boîte**

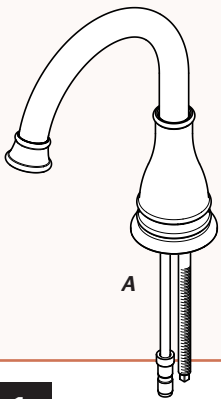

A

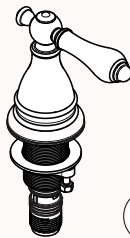

B (x2)

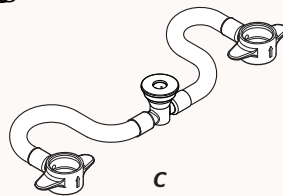

C

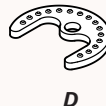

D



E



F (x2)



G (x2)

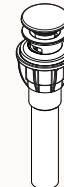

H

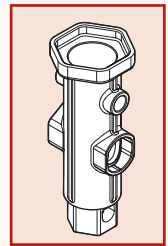

**Quick Install™  
Tool**

**1 Turn Off Water Supply • Cierre el suministro de agua • Couper l'alimentation en eau**



Locate water supply inlets and shut off the water supply valves. These are usually found under the sink or near the water meter. If you are replacing an existing faucet, remove the old faucet from the sink and clean the sink surface thoroughly.

Ubique las entradas del suministro de agua y cierre las válvulas de suministro de agua. Generalmente se encuentran debajo del fregadero o cerca del medidor de agua. Si se trata de un reemplazo de grifo, quite el grifo viejo y limpie completamente la superficie del fregadero.

Repérer les arrivées d'eau et fermer leurs robinets. Ces robinets se trouvent généralement sous le lavabo ou à côté du compteur d'eau. En cas de remplacement d'un robinet existant, le déposer du lavabo et nettoyer soigneusement la surface de ce dernier.

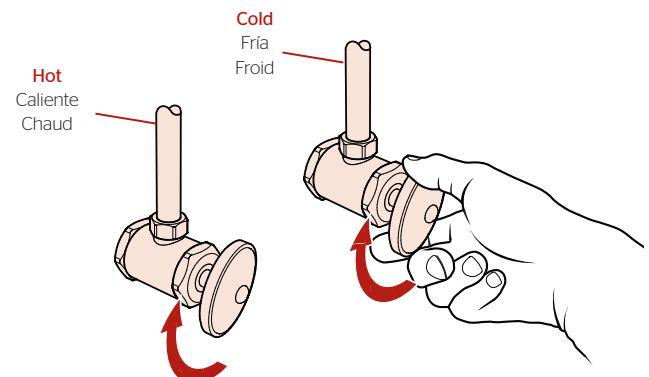

## 2 Prepare & Install Valve Bodies

Prepare e instale los cuerpos de la válvula  
Préparez et installez les vannes



Phillips Screwdriver  
Destornillador de estrella  
Tournevis Phillips



B (x2)



F (x2)

### 2A Disassemble Valves

Desensamble las válvulas  
Démontez les valves

x2

Hot & Cold  
Caliente y fría  
Chaud et froid

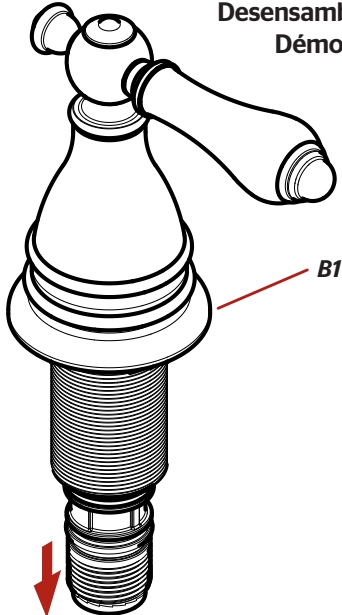

B1

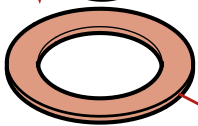

B2

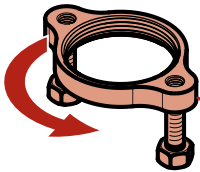

B3

Save for Step 2D.  
Reserve para el paso 2D.  
Sauf pour l'étape 2D.

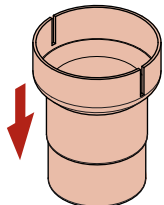

Discard  
Descarte  
Écart

### 2B Valve Installation

Instalación de las válvulas  
Installation de valves

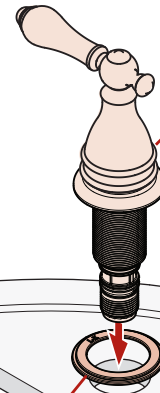

B1 Red (Hot)  
Rojo (caliente)  
Rouge (chaud)

B1 Blue (Cold)  
Azul (fría)  
Bleu (froid)

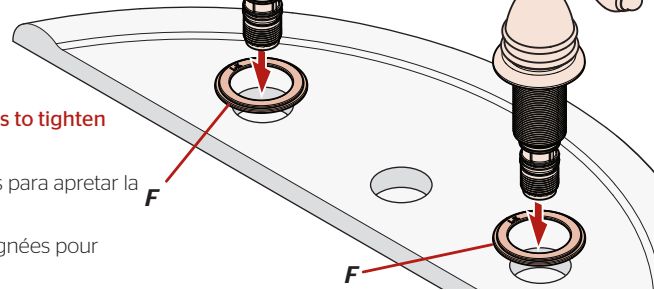

DO NOT use handles to tighten valve.

No utilice las manijas para apretar la válvula.

N'utilisez pas les poignées pour serrer la valve.

### 2C

Closed  
Cerrado  
Fermé

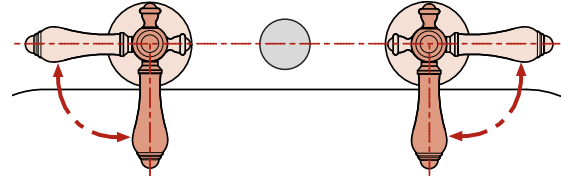

Closed  
Cerrado  
Fermé

Before final tightening, be sure that both handles rotate correctly. As shown.

Antes del apriete final, asegúrese de que ambas manijas giren correctamente. Tal como se muestra.  
Avant le serrage final, soyez sûr que les deux poignées basculent correctement. Comme démontré.

### 2D

Firmly hand tighten.  
Firmemente apriete a mano.  
Fermement serrer à la main.

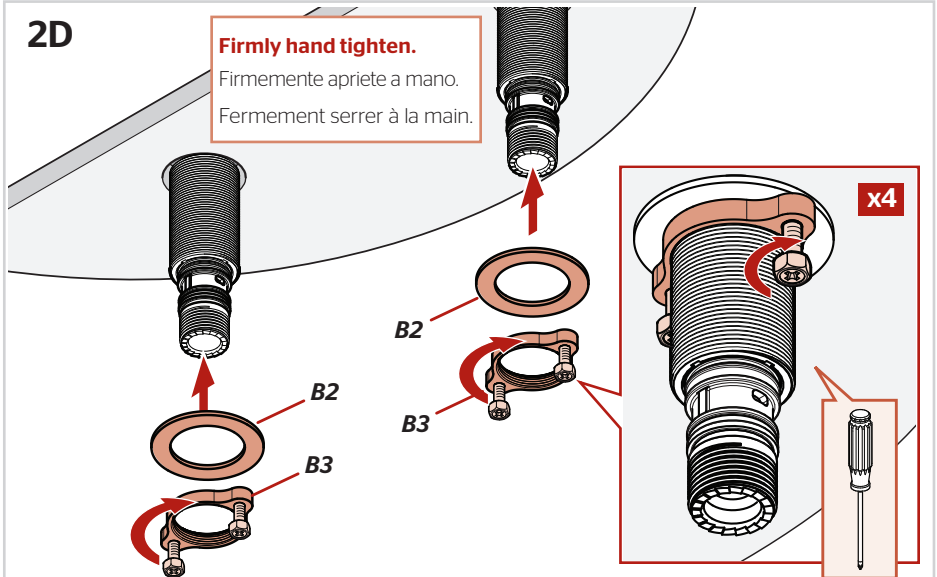

B2

B3

x4

### 3

### Install Handles & Spout

Instale las manijas y el surtidor

Installez les poignées et le bec

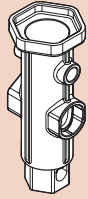

Quick Install™ Tool

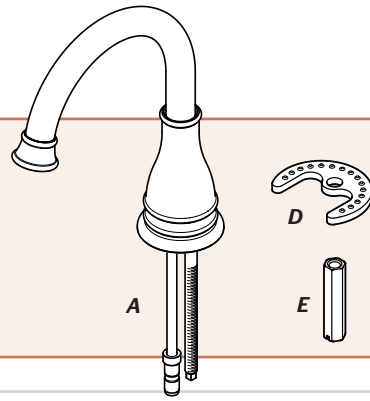

3A

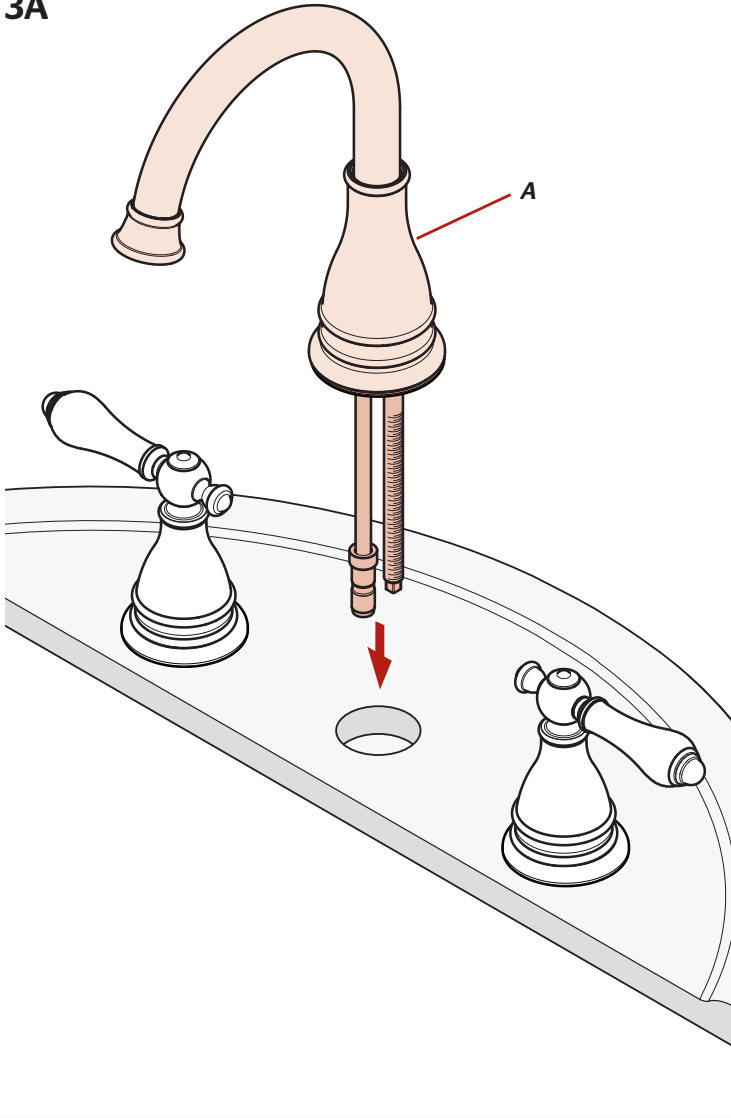

3B

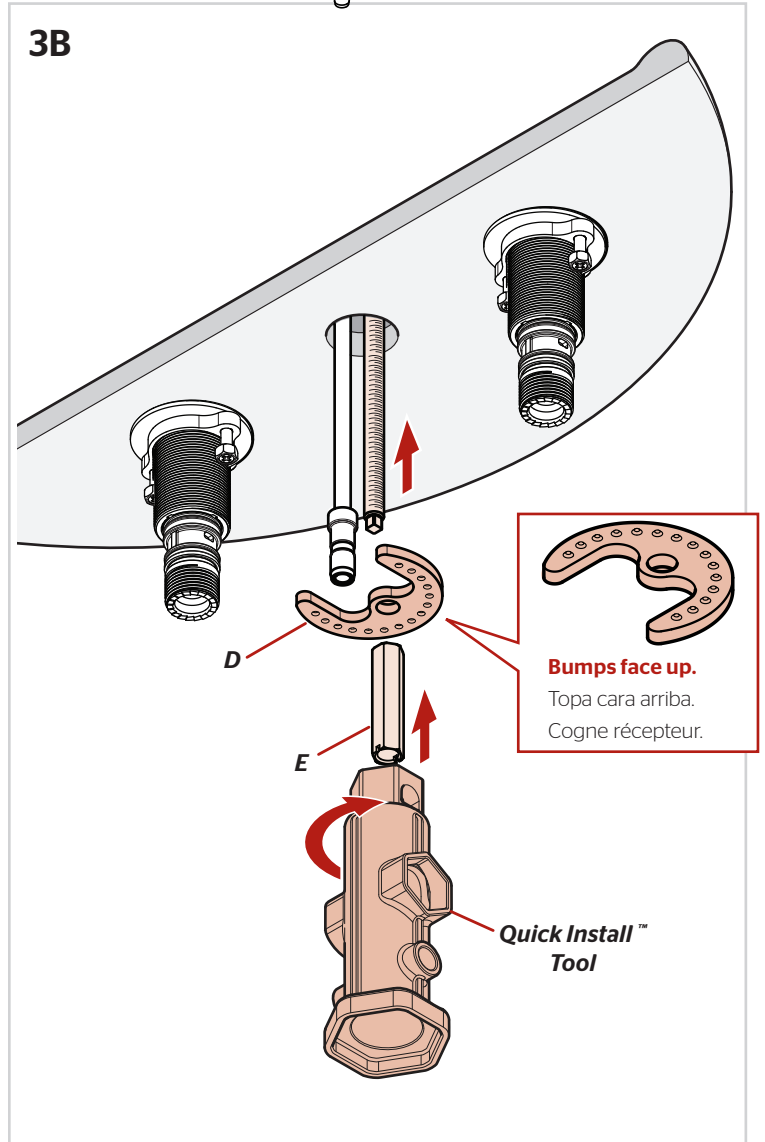

# 4

## Install Hose

Instale la manguera

Posez le tuyau

No Tools Required for This Step  
 No se necesitan herramientas para este paso  
 Aucun outil n'est nécessaire pour cette étape

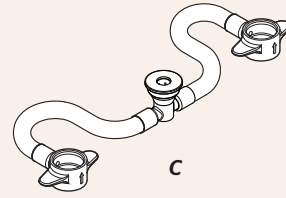

### 4A

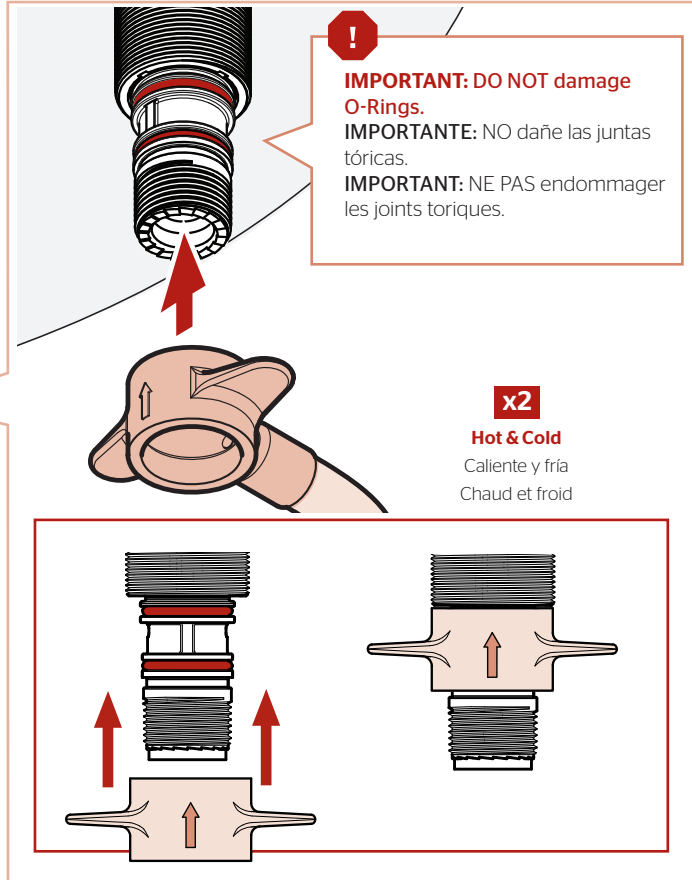
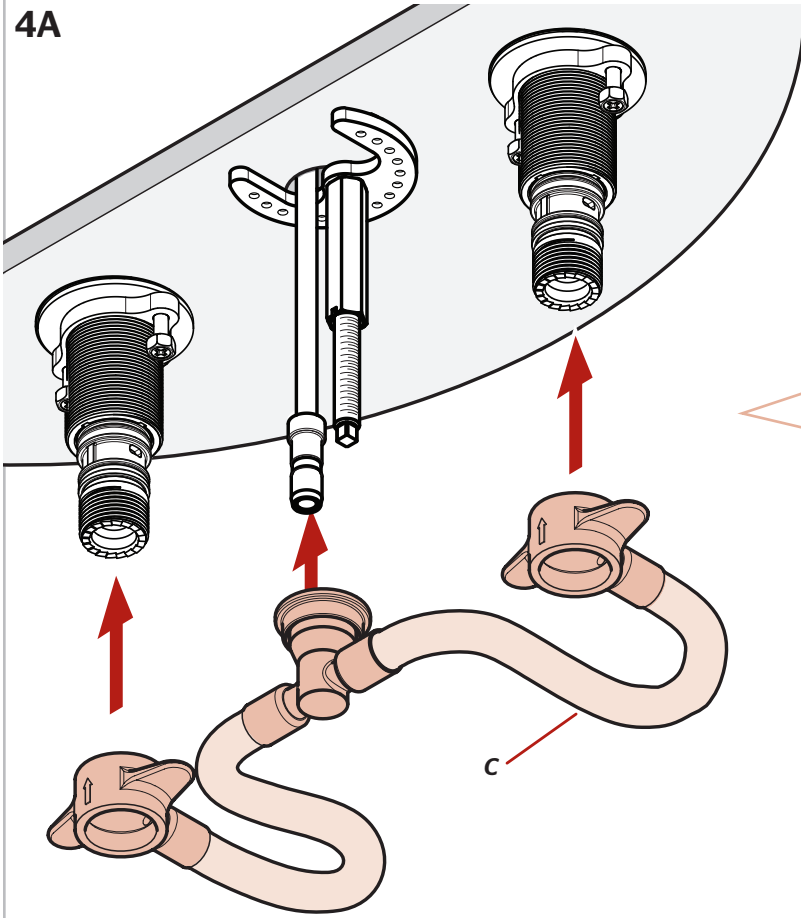

**IMPORTANT: DO NOT damage O-Rings.**  
**IMPORTANTE: NO dañe las juntas tóricas.**  
**IMPORTANT: NE PAS endommager les joints toriques.**

x2

**Hot & Cold**  
 Caliente y fría  
 Chaud et froid

### 4B

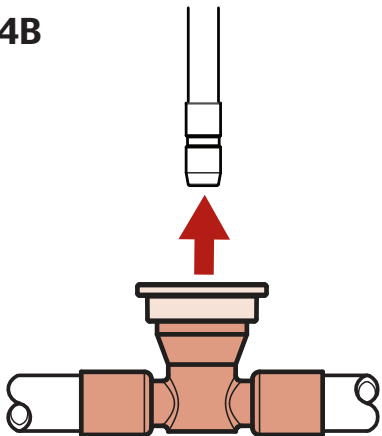

**Check to see if the connection is secure by pulling down the center connector avoiding the green cap. If it does not pull off the receiving tube, connection is secure.**

Compruebe para ver si la conexión es segura tirando abajo del conector de centro que evita el casquillo verde. Si no arranca el tubo de recepción, la conexión es segura.

rifiez pour voir si le raccordement est bloqué par la traction en bas du connecteur central évitant le chapeau vert. S'il ne retire pas le tube de réception, le raccordement est bloqué

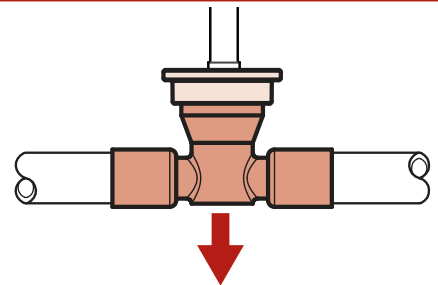

## 5 Connect Water Supply Lines

Conecte las tuberías de suministro de agua  
Raccorder les conduites d'alimentation en eau

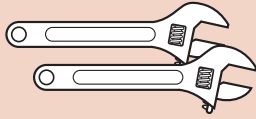

Adjustable Wrenches  
Llaves ajustables  
Clés à mollette



G (x2)

**!** Water Supply Lines not included. Please consult manufacturer and/or its instructions for the correct method of installation of supply lines & fittings.  
**IMPORTANT:** Incorrect application of supply lines and fittings may result in the failure or leak of the supply lines and fitting.

Las tuberías de suministro de agua no están incluidas. Consulte por favor el fabricante y/o sus instrucciones para el método correcto de instalación de líneas de suministro y de guarniciones.

**IMPORTANTE:** El uso incorrecto de líneas de suministro y de guarniciones puede dar lugar a la falta o al escape de las líneas de suministro y de la guarnición.

Les tuyaux d'arrivée d'eau ne sont pas fournis. Veuillez consulter le fabricant et/ou ses instructions pour la méthode correcte d'installation des conduites d'alimentation en eau et des accessoires.

**IMPORTANT:** Mauvaise application des lignes d'alimentation et accessoires peut entraîner la défaillance ou la fuite.

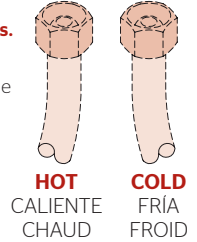

5A

x2

Hot & Cold  
Caliente y fría  
Chaud et froid

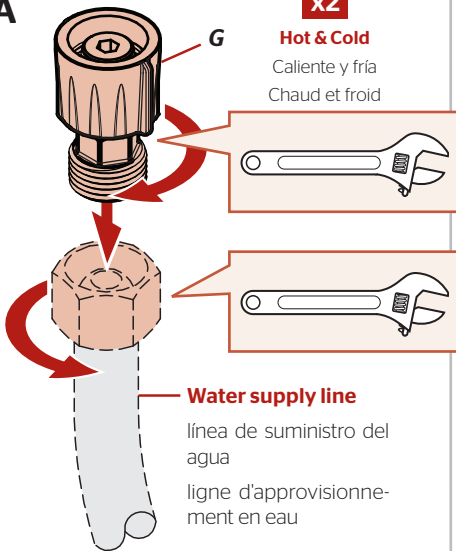

Water supply line

línea de suministro del agua  
ligne d'approvisionnement en eau

5B

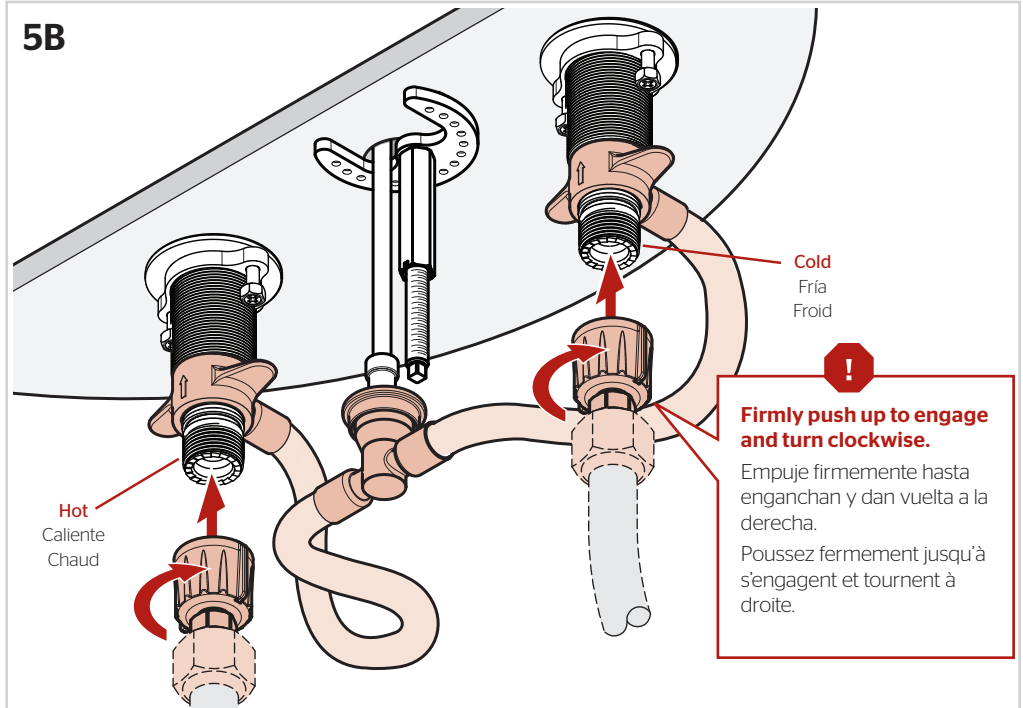

**!** Firmly push up to engage and turn clockwise.

Empuje firmemente hasta enganchar y dan vuelta a la derecha.

Poussez fermement jusqu'à s'engager et tournez à droite.

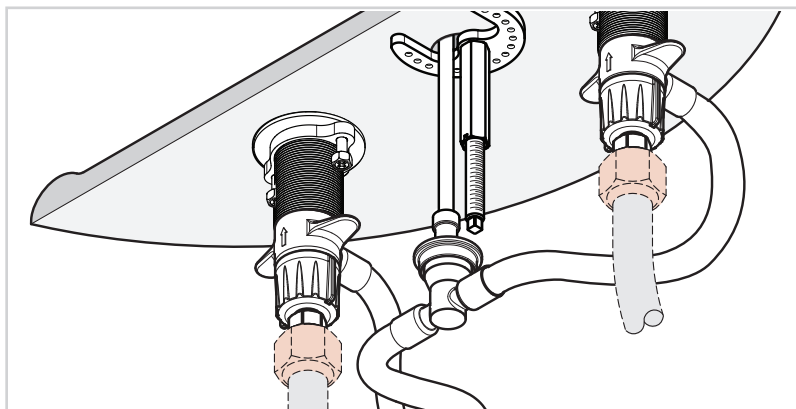
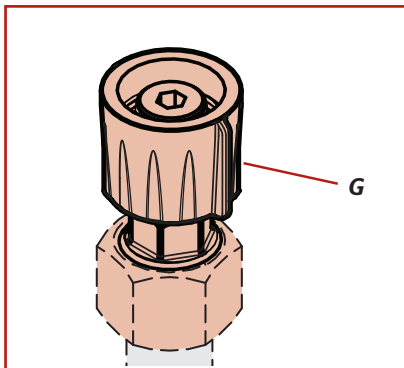

# 6 Prepare & Install Push & Seal™ Drain

## Prepare y instale cuerpo de drenaje Push & Seal™

### Préparez & installez le corps de drainage Push & Seal™

No Tools Required for This Step  
 No se necesitan herramientas para este paso  
 Pas d'outil nécessaire pour cette étape

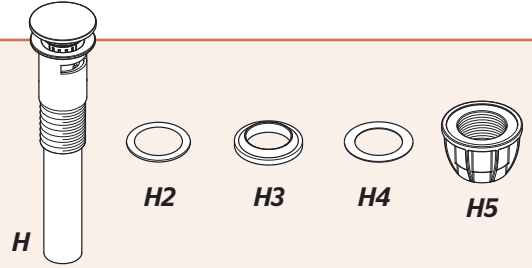

#### 6A Disassemble Pop-Up

Desensamble el cuerpo de drenaje  
 Démontez le corps de drainage

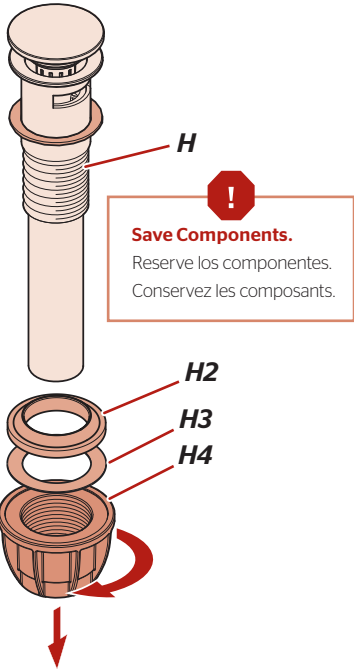

#### 6B

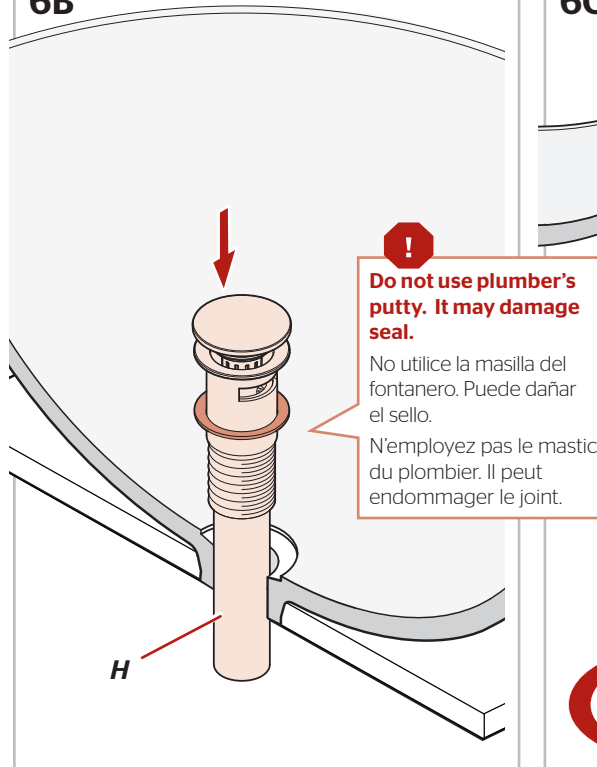

#### 6C

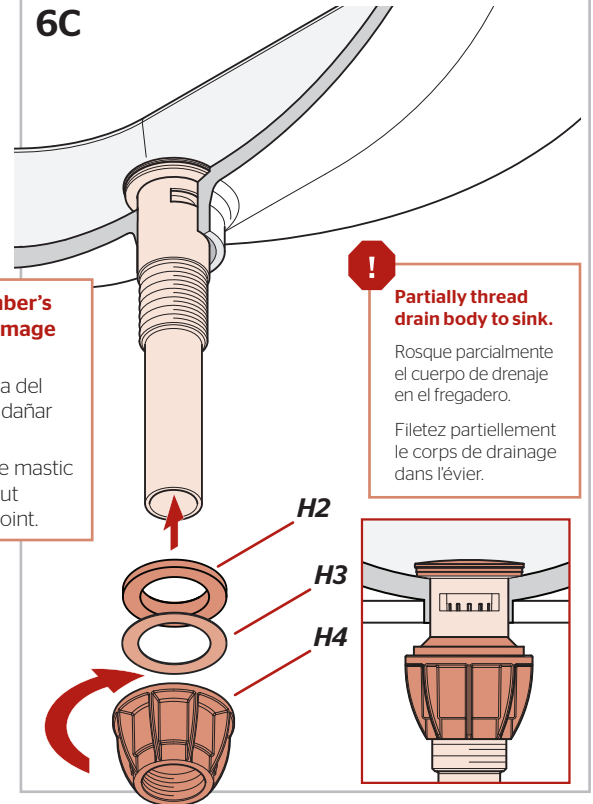

#### 6D

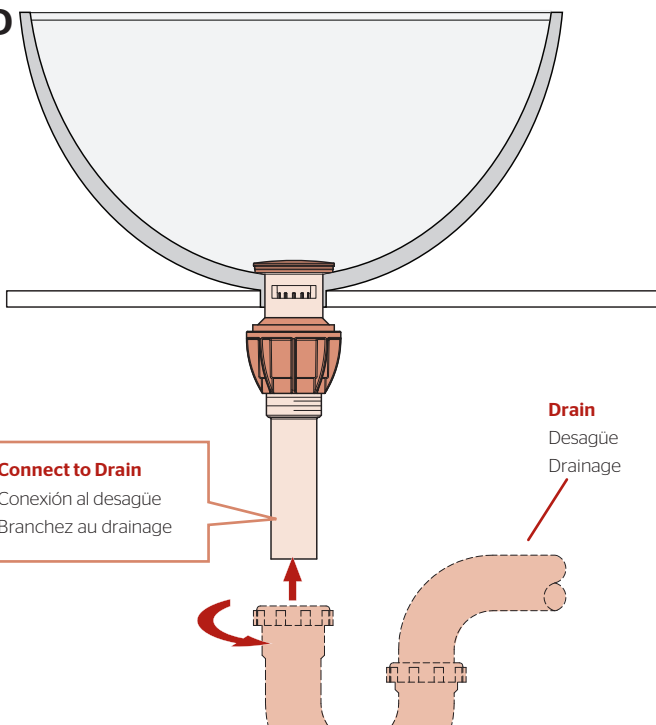

#### 6E

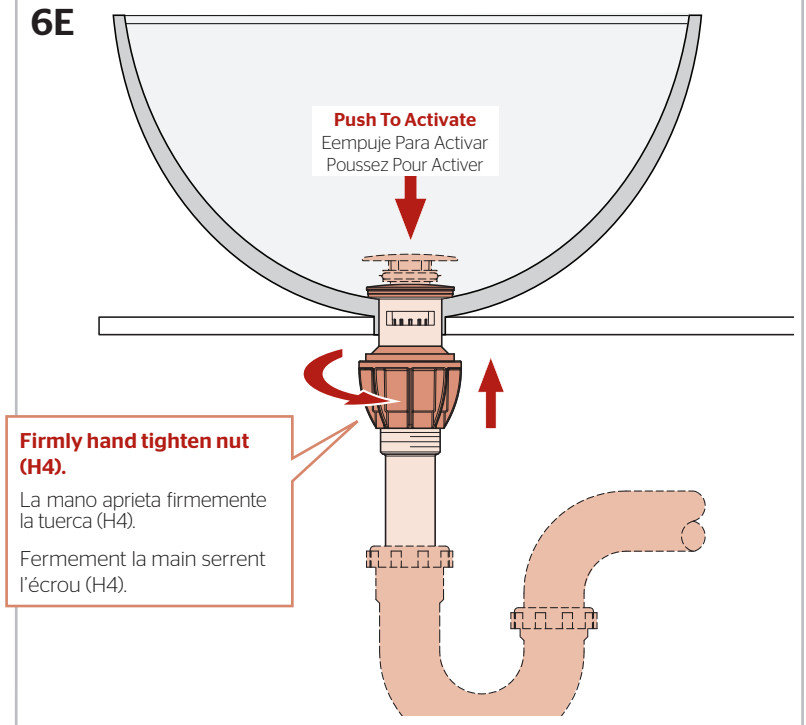

## 7 Turn On Water & Confirm Proper Installation

Active el suministro de agua y confirme que la instalación está adecuadamente efectuada

Ouvrez l'eau et confirmez que l'installation est adéquate

7A

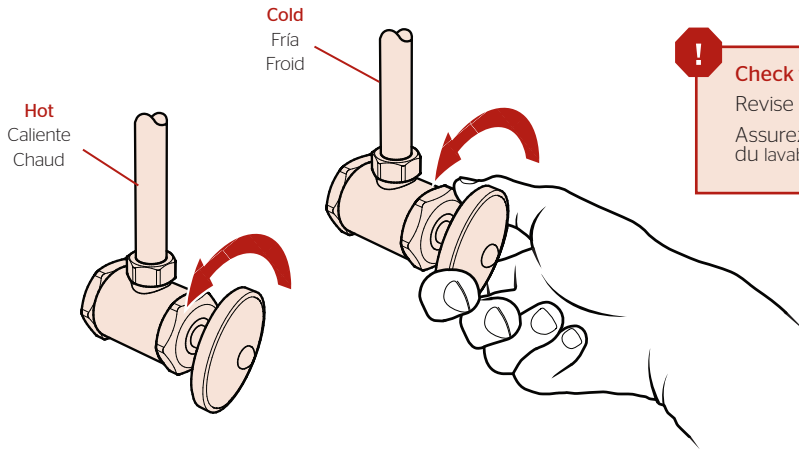

**Check for leaks above and below the sink.**

Revise si hay fugas encima y debajo del fregadero

Assurez-vous qu'il n'y a pas de fuite au dessus ou au dessous du lavabo

## 8 Flush the Faucet

Enjuague el grifo

Vidanger l'robinet

### 8A Remove Aerator

Retire el aereador  
Retirez l'aérateur

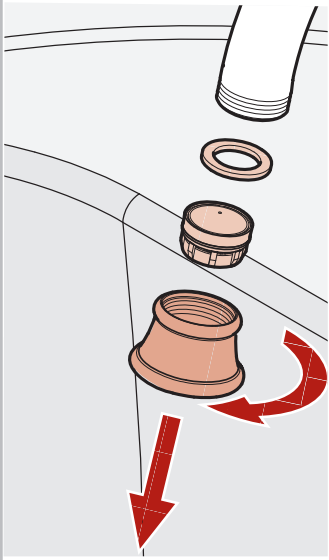

8B

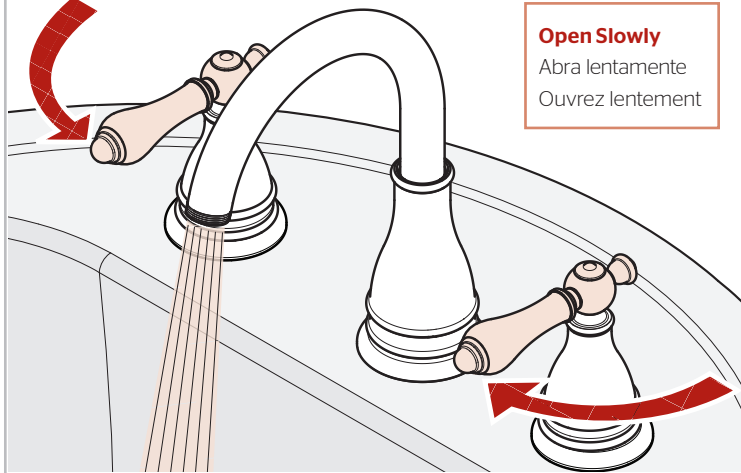

**Open Slowly**

Abra lentamente

Ouvrez lentement

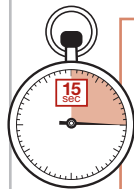

**Allow hot & cold water to run for at least 15 seconds each.**

Deje correr el agua caliente y fría durante al menos 15 segundos cada una.

Laissez couler de l'eau chaude et de l'eau froide pendant au moins 15 secondes chacune.

8C

### Reinstall Aerator

Reinstale el aereador  
Réinstallez l'aérateur

**Hand Tighten**

Apriete con la mano

Serrez manuellement

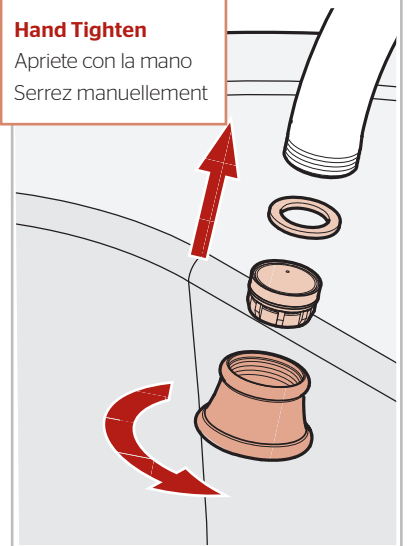

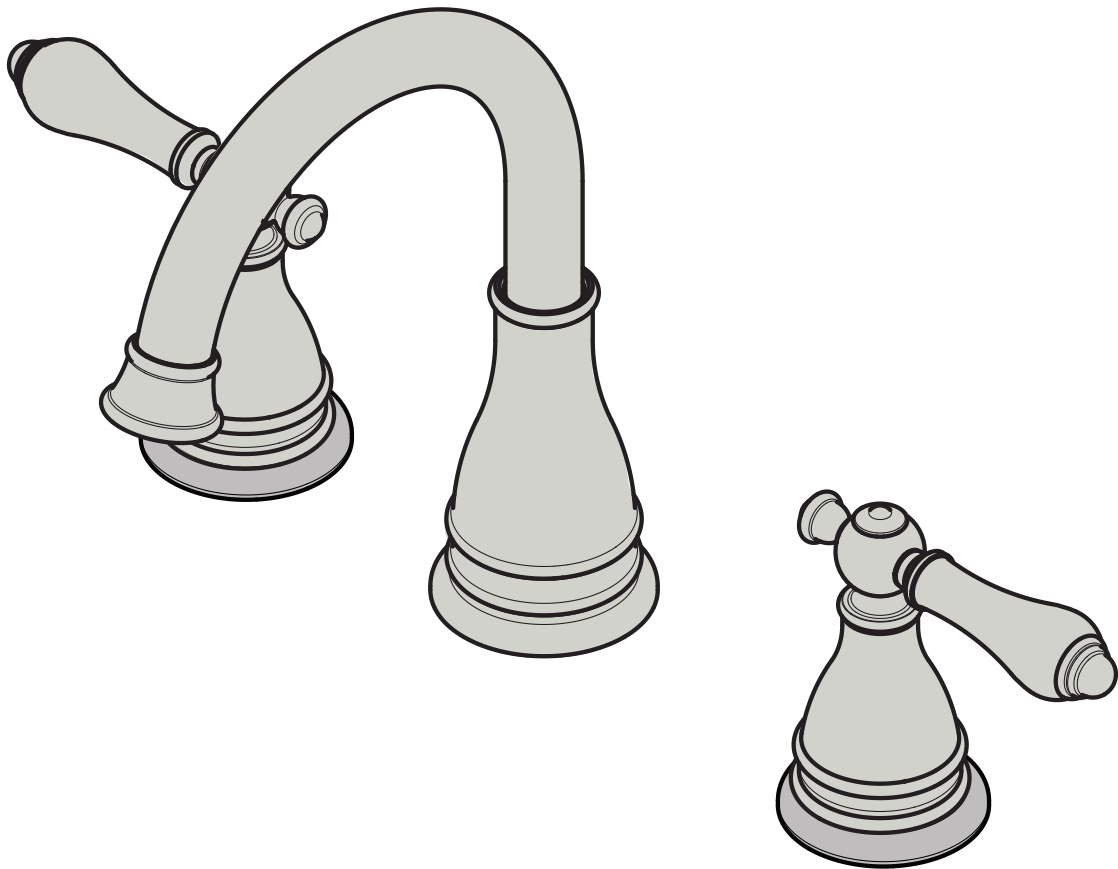

**For Additional Installation Help:**  
Para la instalación adicionales de ayuda:  
Pour aider à l'installation supplémentaires:

**Pfister®**

**1-800-PFAUCET (732-8238)**  
**[pfisterfaucets.com](http://pfisterfaucets.com)**